

HEATIT Z-DIM2 250W

Firmware 1.20

01.05.2022

Ver 2022-A

Installers manual

Art.no. 14 444 40

heatit



White RAL 9003
plastic kit

Dimmer unit

White RAL 9010
plastic kit

TABLE OF CONTENTS

1. Introduction
 2. Statement regarding products from multiple manufacturers
 3. Behaviour within the Z-Wave™ network
 4. Quick Start
 5. Control
 6. Illustrations
 7. Installation and wiring
 8. External Switch
 9. Add/Remove
 - 9.1 Method 1: Standard (Manual)
 - 9.2 Method 2: SmartStart (Automatic)
 10. Factory Reset
 11. Startup
 12. LED blinking patterns description
 13. QR-Code Placement (DSK)
 14. Security
 15. Node Information Frame
 16. Associations
 - 16.1 Setting and Removing Associations
 17. Association Groups
 18. Configuration Parameters
 19. Autocalibration of maximum dim level
 20. Command Classes
 - 20.1 Basic Command Class
 - 20.2 Multilevel Switch Command Class
 - 20.3 Meter Command Class
 - 20.4 Indicator Command Class
 - 20.5 Central Scene Command Class
 21. Supported Command Classes
- Product info

1. INTRODUCTION

Heatit Z-Dim2 is a Z-Wave™ rotary dimmer for many different types of light fixtures. The Heatit Z-Dim2 works on most low loads without causing flickering.

The dimmer is equipped with an external switch option. This allows you to dim and turn on/off the load from an external switch.

Heatit Z-Dim2 is very well suited for LED, and fits into System 55 frames. When connecting low loads it is recommended to use a bypass.

NB! DIMMING

Dimming may be challenging, and we recommend checking the compatibility of different light sources before installation. We are happy to answer any questions.

2. STATEMENT REGARDING PRODUCTS FROM MULTIPLE MANUFACTURERS

Please read this before installation

This device may be used with all devices certified with the Z-Wave Plus™ certificate and should be compatible with such devices produced by any manufacturer. Every primary controller is different depending on the manufacturer, their target audience and intended use/application. Please review the functionalities implemented by the primary controller you intend to use with our Z-Wave Plus certified device to ensure that it provides the necessary controls to take full advantage of our product's capabilities.

3. BEHAVIOUR WITHIN THE Z-WAVE™ NETWORK

This device may be operated within any Z-Wave network with Z-Wave-certified devices from other manufacturers. All non-battery-operated nodes within the network will act as repeaters regardless of manufacturer to increase the reliability of the network. On delivery, the device does not belong to any Z-Wave network. The device needs to be added to an existing network to communicate with the other devices within it. Devices may also be removed from a network. The add/remove processes are initiated by the primary controller of the Z-Wave network.

4. QUICK START

1. Switch off the mains voltage (turn off the fuse).
2. Open the junction box.
3. Connect according to the wiring diagram as shown in chapter 7 "Installation & wiring".
4. After verifying the connections, switch on the mains voltage.
5. Set the primary controller in add mode (security/non-security).
6. Press the reset button on dimmer 3 times in a rapid sequence. Heatit Z-Dim2 is now included in your Z-Wave network.



heatit
CONTROLS

5. CONTROL

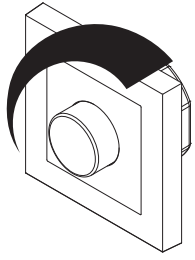

Increase / decrease

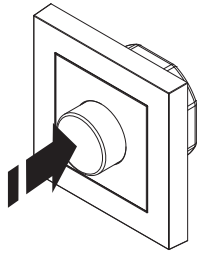

On / Off

6. ILLUSTRATIONS

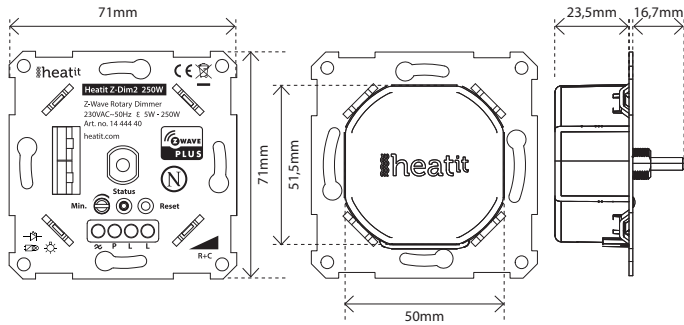

7. INSTALLATION AND WIRING

Installation must be done by a qualified electrical installer in accordance with the national building codes. Before installation, disconnect any power to the dimmer mains. During the installation process, the fuse must be turned off AT ALL TIMES!

NB! Max tightening torque for terminal screws: 2Nm

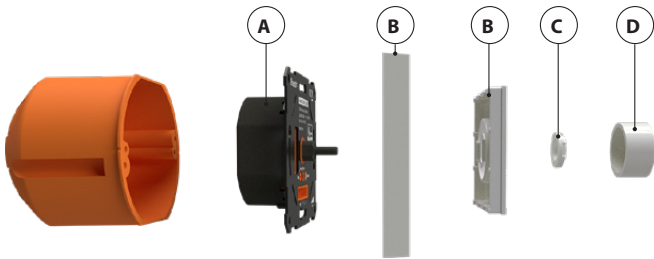

NB! This is a 2-wire dimmer so the **Neutral is only connected to the load** and not the dimmer itself.

1. Turn off the fuse.
2. Connect the Live to the dimmer terminal marked "L".
3. Connect the load terminal marked "L" to the dimmer terminal marked
4. Install the dimmer (A) in the wall box. Make sure that no wires are pinched.
5. Attach the cover (B) with the supplied nut (C).
6. Attach the button (D) with a simple push.

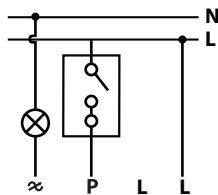

Wiring diagram

- S1: Dimmer knob.
Can be used as a scene controller.
- S2: External switch connected to P.
Used for either dimming or scene controller.

8. EXTERNAL SWITCH

Momentary Switch (NO)

When using a momentary switch, the switch functionality can be selected using Parameter 7.

The switch must be a normally open switch.

9. ADD/REMOVE

Please read this before installation

The primary controller/gateway has a mode for adding or removing devices. Please refer to your primary controller manual on how to set the primary controller in add/remove mode. The device may only be added or removed from the network if the primary controller is in add/remove mode. When the device is removed from the network, it will **NOT** revert to factory settings.

There are two ways to add the device to a Z-Wave network.

9.1 Method 1: Standard (Manual)

Add/remove mode is indicated on the device by a blinking green LED. It indicates this for 90 seconds until a timeout occurs, or until the module has been added to/removed from the network. To start the configuration process press the Reset button, or the external switch connected to P, 3 times in rapid succession. The LED will blink green for 3 seconds if adding/removing is successful. The device is now ready for use with default settings.



NB! When the device is removed from the gateway, the parameters are not reset. To reset the parameters, see Chapter 10 "Factory reset".

If inclusion fails, please perform a "remove device" process and try again. If inclusion fails again, please see Chapter 10 "Factory reset".

9.2 Method 2: SmartStart (Automatic)

SmartStart enabled products may be added to a Z-Wave network by scanning the Z-Wave QR-Code on the product if your primary controller supports SmartStart inclusion. No further action is required and the SmartStart product will be added automatically after being powered on within range of the primary controller.

10. FACTORY RESET

Please read this before installation

Press and hold the reset button. After 3 seconds the LED will start to blink in green. After 20 seconds the LED will shine solid green for 3 seconds. You may now release the button.



Please attempt exclusion before using factory reset.

11. STARTUP

After powering up the device for the first time, all the parameters will have default settings.

12. LED BLINKING PATTERNS DESCRIPTION

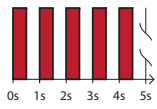
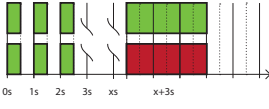
The device supports numerous LED blinking patterns to make it as easy as possible to identify what the device is doing.

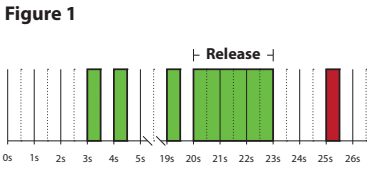
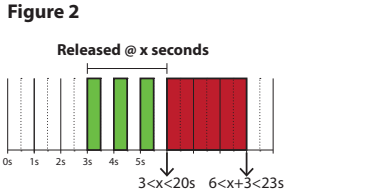
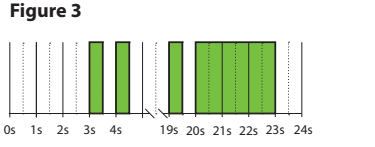
<p>Device Not in Network The LED will flash in red when the device is not added to a Z-Wave network.</p>	
<p>Add/Remove When device enters add/remove mode the LED will flash green. If successful, the LED will light up in green for 3 seconds. If unsuccessful, the LED will light up in red for 3 seconds.</p>	<p>Successful</p>  <p>Unsuccessful</p> 
<p>Factory Reset If the button is pressed for more than 3 seconds, the GREEN LED will start flashing. When the button has been pressed for 20 seconds, the GREEN LED will light up for 3 seconds.</p> <p>Figure 1 (success) Within the 3 second period the button must be released. If the button is released within this period, the device will reset and start flashing because it is not included in a gateway.</p> <p>Figure 2 (fail) If the button is released before the 3 second period, the device will indicate fail by turning RED LED on for 3 seconds.</p> <p>Figure 3 (fail) The button MUST be released between 20 and 23 seconds for local reset to take place. If held longer, the device will ignore the command.</p>	<p>Figure 1</p>  <p>Figure 2</p>  <p>Figure 3</p> 

13. QR-CODE PLACEMENT (DSK)

The QR-Code is needed when including a device using S2 security or SmartStart. The DSK can be found in the QR-Code and is located;

- On the product.
- On the Quick Guide.
- On the gift box.

14. SECURITY

S2 security enhances Z-Wave Plus with an additional layer of AES 128-bit encryption of the wireless Z-Wave communication to prevent hacking and man-in-middle attacks on the home network. This device supports S2 and has a Z-Wave DSK QR-Code label that may be used when the module is added to the Z-Wave home network. The primary controller will ask for a 5-digit code, which can be found underneath the QR-Code. The primary controller will then ask you to confirm the rest of the code that is contained in the QR-Code.

15. NODE INFORMATION FRAME

The node information frame is the "business card" of a Z-Wave device. It contains information about the device type and its technical features. The add and remove procedure of the device is confirmed by sending out a node information frame. Besides this, it may be necessary for certain network operations to send out a node information frame.

16. ASSOCIATIONS

Z-Wave devices interact with other Z-Wave devices. The relationship between one device controlling another device is called an association. In order to control a subordinate device, the controlling device needs to maintain a list of devices that will receive controlling commands. These lists are called "Association Groups". They are always related to the specific event triggered (e.g., sensor reports). In case the event is triggered, all devices stored in the respective association group will receive a joint wireless command.

16.1 Setting and Removing Associations

Associations may be assigned and removed via Z-Wave commands. Please refer to your primary controller/Z-Wave gateway for more information.

17. ASSOCIATION GROUPS

MULTI LEVEL SWITCH DEVICE	DESCRIPTION
<p>Group 1 Lifeline</p>	<p>Lifeline. (Normally used by the Z-Wave Controller) Sends:</p> <ul style="list-style-type: none"> - Switch Multilevel Report - Device Reset Notification - Indicator Report - Meter Report - Central Scene Notification - Configuration Report <p>Max nodes in group: 5</p>
<p>Group 2 Basic Set</p>	<p>-Basic Set. Send Basic Set commands representing the status of the dimmer when changed from S1 or S2.</p> <p>OFF/ON (0x00, 0xFF) 1-99% (0x01, 0x63)</p> <p>Max nodes in group: 5</p>
<p>Group 3 Switch Multilevel</p>	<p>-Switch Multilevel When S1 or S2 is pressed/held</p> <p>Press: OFF/ON (0x00, 0xFF) Held: Multilevel Switch Start Level Change/Stop Level Change Command Level Increase Start / Level Increase Stop Level Decrease Start / Level Decrease Stop</p> <p>Max nodes in group: 5</p>

18. CONFIGURATION PARAMETERS

Z-Wave products are supposed to work out of the box after inclusion. Some device configuration may, however, alter the functionality to better serve user needs or unlock further enhanced features. All the parameters below do not feature altering capabilities, advanced or read only flag.

PARA NO#	PARA SIZE (BYTE)	NAME	SHORT DESCRIPTION/COMMENT	MIN	MAX	DEFAULT	DESCRIPTION OF VALUE
1	1	Power restore level	The state the dimmer should return to once power is restored after a power failure.	0	0	100	Off
				1	99		1%-99%
				100	100		Returns to level before power outage (Default)
2	1	Switch ON level	Defines the dimming level when restored from the OFF state.	0	0	0	Restores last dim level (Default)
				1	99		1%-99%
3	4	Automatic turn OFF	Time for the dimmer to turn off automatically after turning it on.	0	0	0	Auto OFF disabled (Default)
				1	86400		Duration 1-86400 seconds
4	4	Automatic turn ON	Time for the dimmer to turn on automatically after turning it off.	0	0	0	Auto ON disabled (Default)
				1	86400		Duration 1-86400 seconds
5	1	Turn off delay time	The time it takes before the dimmer turns off after turning it off.	0	0	0	Disabled (Default)
				1	60		Duration 1-60 seconds

PARA NO#	PARA SIZE (BYTE)	NAME	SHORT DESCRIPTION/COMMENT	MIN	MAX	DEFAULT	DESCRIPTION OF VALUE
6	1	Rotary wheel press functionality	Decide the rotary wheel press function.	0	0	0	Double click to 100% (Default)
				1	1		Scene controller function
				2	2		Disabled
7	1	External switch functionality	Decide how external switch function.	0	0	1	Double click to 100%, external switch pair and dimming
				1	1		Scene controller function (Default)
				2	2		Disabled
8	1	Dimming duration	Define how long it takes to dim when using the external switch.	0	0	50	Instantly
				1	100		1-100 = 0.1-10 sec (Default 5 seconds)
9	1	Choose the dimmer curve	Choose if the dimmer uses Linear or Logarithmic dimming.	0	0	0	Linear dimming (Default)
				1	1		Logarithmic dimming
10	1	Load dimming mode	Choose the dimming type.	0	0	0	Trailing edge (Default)
				1	1		Leading edge
11	1	Maximum dim level	Highest dim level of the dimmer.	2	99	90	2%-99% (Default 90)
				If the dimmer stops working after adjusting this parameter, turn off and on the power to the device and let it recalibrate.			
12	1	Meter report threshold	Threshold for device to send meter report in W.	0	0	10	Disabled
				1	250		1-250W (Default 10W)
13	2	Meter report interval	Time interval between consecutive meter reports in seconds.	30	65535	780	30-65535 sec (Default 780)

19. AUTOCALIBRATION OF MAXIMUM DIM LEVEL

The dimmer supports an autocalibration feature for the maximum dim level. Autocalibration will initiate if the dimmer detects flickering. The Maximum dim level Parameter (11) will be updated automatically upon completion of the autocalibration. The value will also be reported to the gateway.

20. COMMAND CLASSES

Besides the mandatory command classes, the device has support for the following command classes:

20.1 Basic Command Class

Basic Set commands are mapped to Multilevel Switch and are also used to control the dimming level and associated devices in group 2. Uses the following values:

0x00 = OFF
0xFF = ON
0x01...0x63 = 1% - 99%

20.2 Multilevel Switch Command Class

Multilevel Switch commands are used to control the dimming level and associated devices in group 3.

Uses the following values:
0x00 = OFF
0xFF = ON
0x01...0x63 = 1% - 99%

20.3 Meter Command Class

The device supports Meter Command Class Get, and the dimmer will only respond on supported electric meter scales: kWh (accumulated) and Watt (instant).

The device will report when asked:

Rate import: Import (0x01)
Meter type: Electric meter (0x01)
Precision: 2 decimals (0x02)

PRECISION (VALUE)	SCALE SUPPORTED (VALUE)	SIZE
2 decimals (0x02)	kWh (0x00)	4
2 decimals (0x02)	W (0x02)	2

20.4 Indicator Command Class

The device supports Indicator Command Class.

The indicator Command Class will turn ON/OFF internal LED as wanted as well as turning the load ON/OFF.

20.5 Central Scene Command Class

The device supports the Central Scene Command Class. This command class is used to perform actions chosen in the controller.

To use the Scene controller functionality from the rotary knob, set Parameter 6 (Rotary wheel press functionality) to 1 (Scene controller function).

The following attributes are supported:

BUTTON	SCENENUMBER	KEY ATTRIBUTE	DESCRIPTION
S1 (Rotary knob)	1	0x00	Pressed 1 time
		0x01	Released (send only after button was held)
		0x02	Held down (send only when held for more than 700ms)
		0x03	Pressed 2 times
		0x04	Pressed 3 times
		0x05	Pressed 4 times
		0x06	Pressed 5 times
S2 (External switch)	2	0x00	Pressed 1 time
		0x01	Released (send only after button was held)
		0x02	Held down (send only when held for more than 700ms)
		0x03	Pressed 2 times
		0x04	Pressed 3 times
		0x05	Pressed 4 times
		0x06	Pressed 5 times

21. SUPPORTED COMMAND CLASSES

The following table lists all Command Classes supported by the Z-Wave device. The device supports S0, S2 Authenticated security and S2 Unauthenticated security.

	VERSION	INSECURE ON SECURE INCLUSION	SECURE ON SECURE INCLUSION
Application Status	1	Yes	
Association	2		Yes
Association Group Information	3		Yes
Basic	2		Yes
Configuration	4		Yes
Device Reset Locally	1		Yes
Firmware Update	5		Yes
Manufacturer Specific	2		Yes
Meter	3		Yes
Multichannel Association	3		Yes
Powerlevel	1		Yes
Security	1	Yes	
Security 2	1	Yes	
Supervision	1	Yes	
Switch Multilevel	4		Yes
Indicator	3		Yes
Transport Service	2	Yes	
Version	3		Yes
Z-Wave Plus Information	2	Yes	
Central Scene	3		Yes

PRODUCT INFO Heatit Z-Dim2 250W

FEATURES

- Z-Wave rotary dimmer
- 2-wire
- 5W - 250W LED
- Power metering
- SmartStart
- Firmware update (OTA)
- Overload protection
- Short circuit protection
- Surge protection
- Overheat protection
- External switch
- Min. dim level
- Max. dim level auto-calibration
- Supports encryption mode S0, S2 Authenticated Class, S2 Unauthenticated Class

This product is a security-enabled Z-Wave Plus product with encryption. The product must be used with a security-enabled Z-Wave Controller in order to fully utilize the product.

NB! Dimming may be challenging, and we recommend checking the compatibility of different light sources before installation.

TECHNICAL DATA

Protocol	Z-Wave, 868.4MHz
Chip	Z-Wave 700 chip
Rated voltage	230VAC 50Hz
Power	5W - 250W
Input current	1.1A
Controls	Rotary and push dimming
Ambient temperature	5°C to 40°C
Range RF	Min. 40 meter
Connection	Max. 2.5mm ²
Flush mounting depth	24mm
IP Code	IP 21
Size (LxWxH)	84 x 84 x 43mm
Approvals	Z-Wave Plus V2, CE, Nemko

Working frequency 868.4MHz, Max output power 12.49dBm.
The distance between user and products should be no less than 20 cm.

MAINTENANCE

The device is maintenance-free, but must never be covered.
Only for indoor installation.

ART. NO.	PRODUCT	COLOR	FREQUENCY
14 444 40	Heatit Z-Dim2 250W	White RAL 9003 & RAL 9010	EU 868.4MHz

Heatit Controls AB can not be held liable for typographical errors, other errors or omissions in our information. Product specifications may change without further notice. All electrical installations must be carried out by a licensed electrician. The product must be installed in accordance with national building codes and our installers manual.