

UN80*
UN73*
UN71*

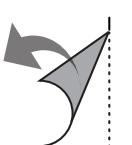

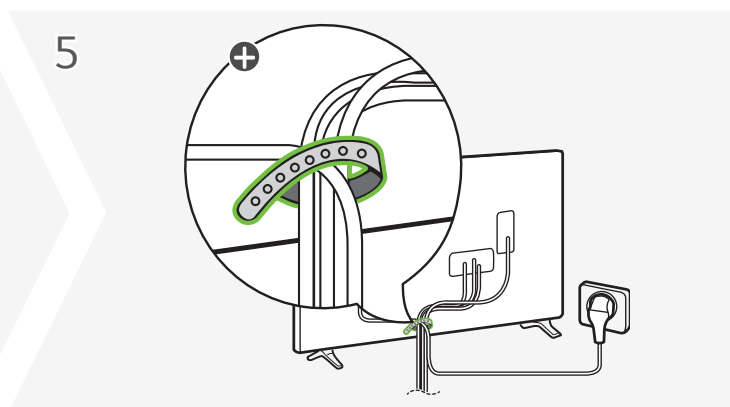

	A	B	C	D	E	F	F-G
	(mm)				(kg)		
43UN71006LB 43UN71003LB	975	627	216	574	80.3	8.4	8.3
43UN73506LD 43UN73006LC 43UN73003LC 43UN73906LE 43UN73903LE	973	623	216	572	85.0	8.1	8.0
43UN80006LC 43UN80003LC	975	625	216	571	86.4	9.1	9.0
Power requirement				AC 100-240 V - 50 / 60 Hz			

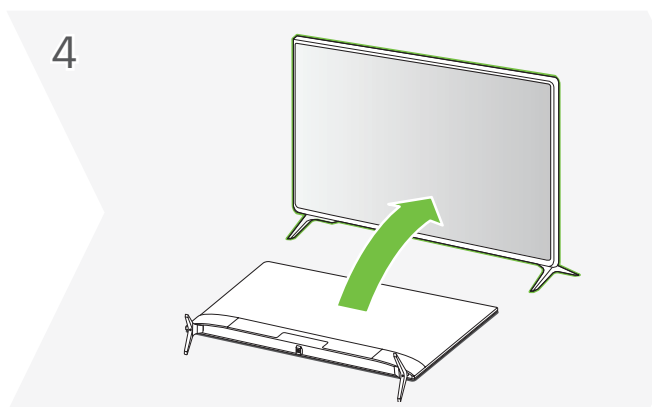
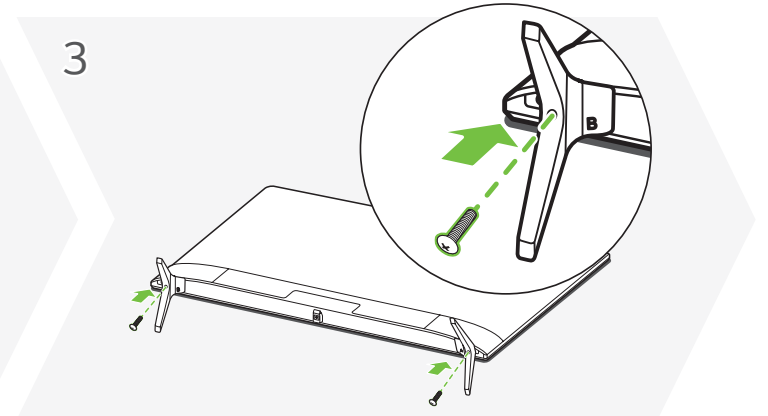
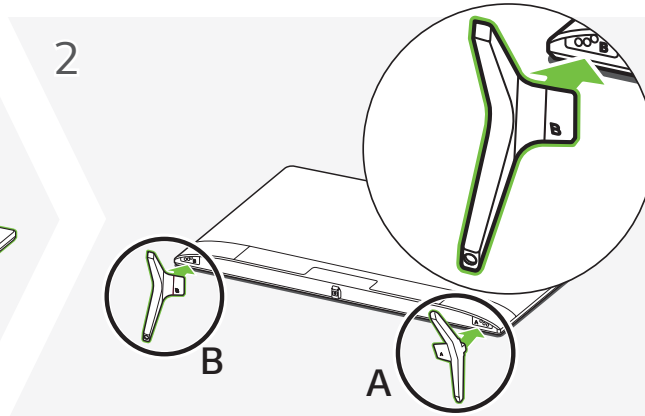
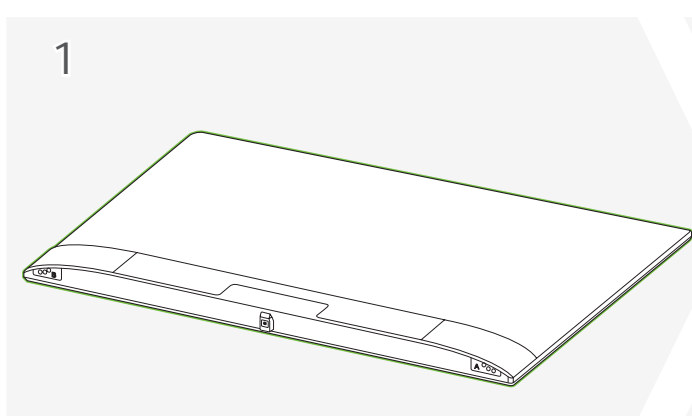
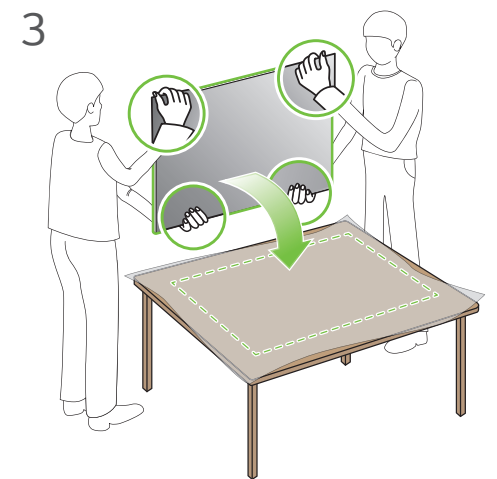
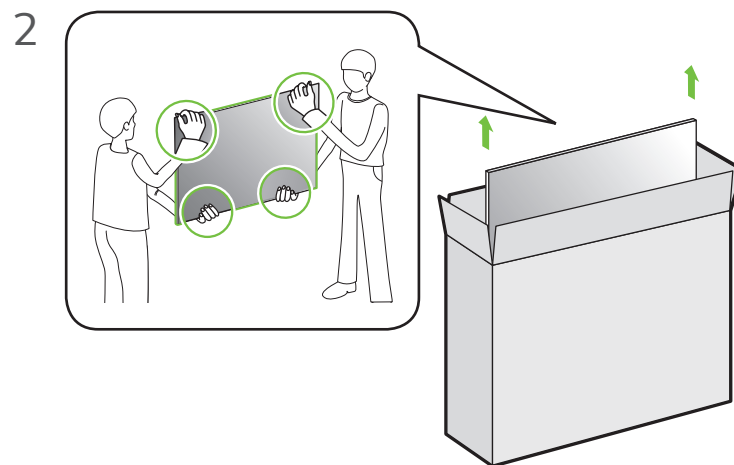
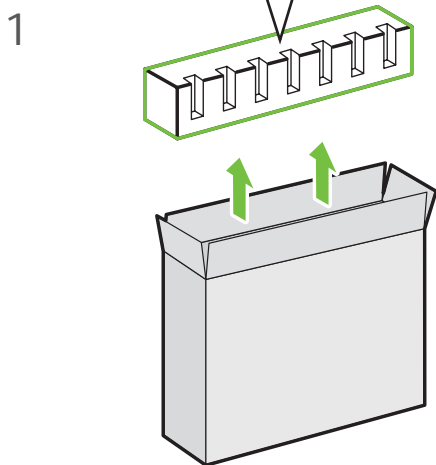
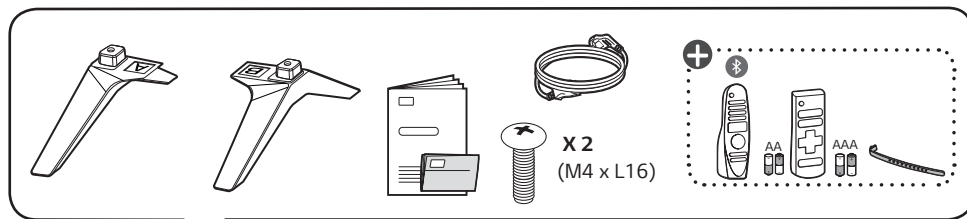
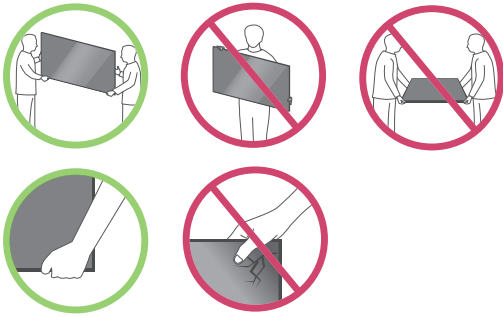
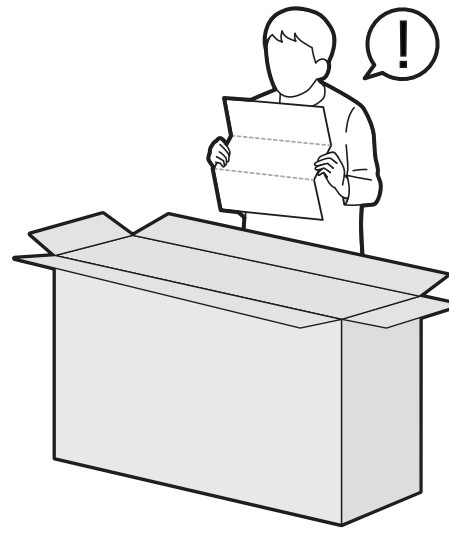
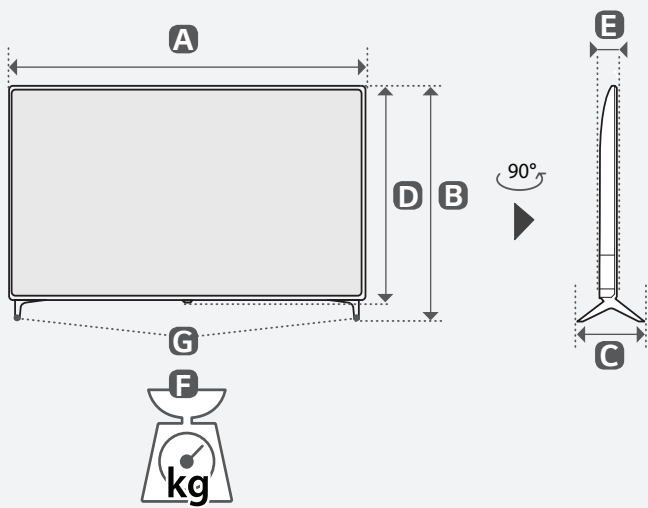
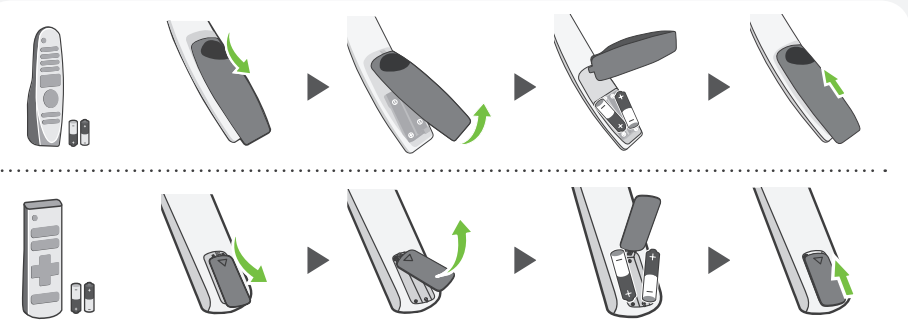
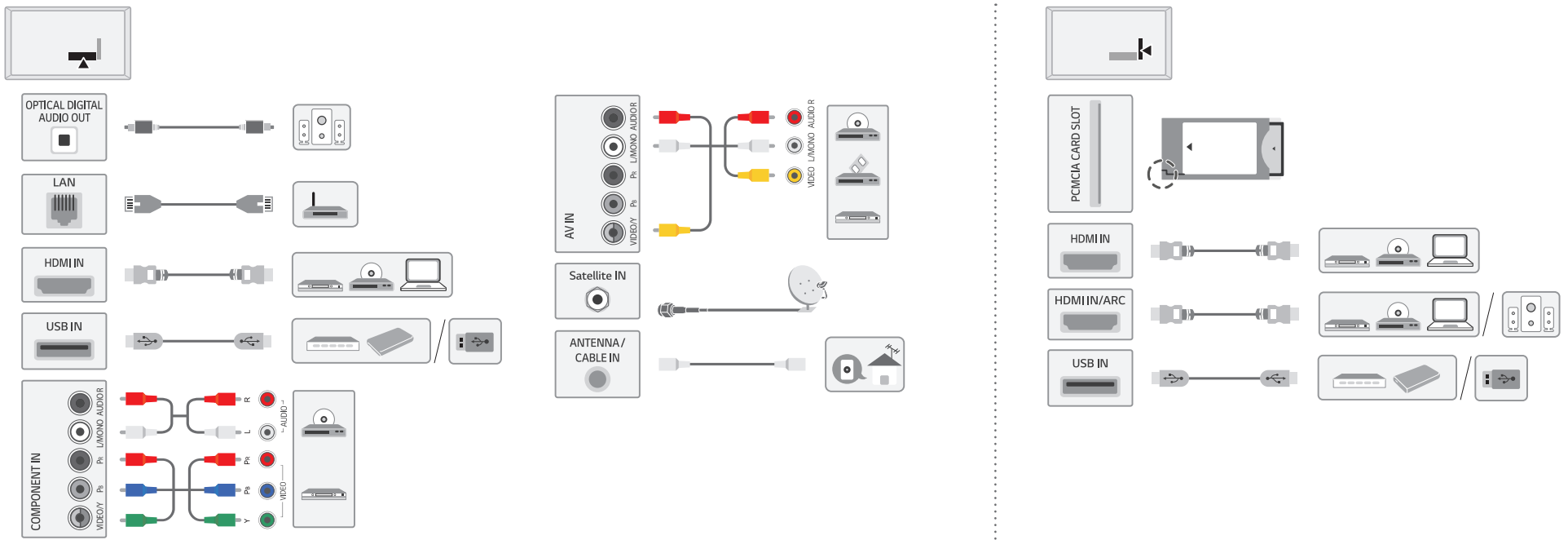

English	· Read Safety and Regulatory.	Hrvatski	· Pročitajte Sigurnost i usklađenost s propisima.	Română	· Consultați manualul referitor la siguranță și reglementare.
Deutsch	· Lesen Sie die Sicherheitsanweisungen und Richtlinien.	Shqip	· Lexoni paragrafin " Siguria dhe rregullimi. "	Български	· Прочетете Безопасност и регулаторни стандарти.
Français	· Lire le document Sécurité et mesures réglementaires.	Bosanski	· Pročitajte dio Sigurnost i propisi.	Eesti	· Lugege ohutus- ja normatiivteavet.
Italiano	· Leggere il manuale Sicurezza e normativa.	Македонски	· Прочитajte за безбедноста и регулативата.	Lietuvių k.	· Perskaitykite Saugos ir norminius reikalavimus.
Español	· Leer Seguridad y normativa.	Svenska	· Läs Säkerhet och föreskrifter.	Latviešu	· Izlasiet sadaju Drošība un normatīvi.
Português	· Ler informações sobre a Segurança e Regulamentos.	Magyar	· Biztonsági szabályzat megtekintése.	Srpski	· Pročitajte odeljak Bezbednost i regulatorna pitanja.
Nederlands	· Veiligheidsinformatie en regelgeving lezen.	Polski	· Prosimy o przeczytanie Zasad bezpieczeństwa i uwag dotyczących przepisów.	Norsk	· Les sikkerhet og forskrifter.
Ελληνικά	· Διαβάστε τις οδηγίες για την ασφάλεια και τους κανονισμούς.	Česky	· Přečtěte si část Bezpečnost a zákonné předpisy.	Dansk	· Læs sikkerhed og lovmæssige bestemmelser.
Slovenščina	· Preberite varnostne in regulativne vidike.	Slovenčina	· Přečítajte si bezpečnostné a regulačné informácie.	Suomi	· Lue Turvallisuus ja säännökset -osio.

+ Depending on model / Abhängig vom Modell / Selon le modèle / In base al modello / En función del modelo / Dependendo do modelo / Afhankelijk van het model / Av λογα με το μοντ λο / Odvisno od modela / Tipusfüggő / Zależnie od modelu / Závisí na modelu / V závislosti od modelu / În funcție de model / в зависимости от модели / Sõltub mudelist / Priklauso nuo modelio / Atkarībā no modeļa / U zavisnosti od modela / Ovisno o modelu / Në varësi të modelit / Ovisno o modelu / во зависност од моделот / Beroende på modell / Avhengig av modell / Afhængigt af modellen / Mallin mukaan